

|                       |                   |                                   |                                    |                           |          |
|-----------------------|-------------------|-----------------------------------|------------------------------------|---------------------------|----------|
| <b>Project title:</b> | <b>EF2019V004</b> | <b>Project no.:</b>               | <b>Project rev.:</b>               | <b>Page</b>               | <b>1</b> |
| <b>Page title:</b>    |                   | <b>Drawing no.:</b>               | <b>Page rev.:</b>                  | <b>Previous page:</b>     |          |
| <b>Filename:</b>      | EF2019V004        | <b>Constructor (project/page)</b> | <b>Last printed:</b> 24.01.2020    | <b>Next page:</b> 2       |          |
| <b>Page ref.:</b>     |                   | <b>Appr. (date/sign.)</b>         | <b>Last correction:</b> 03.10.2019 | <b>Number of pages:</b> 9 |          |

1 2 3 4 5 6 7 8

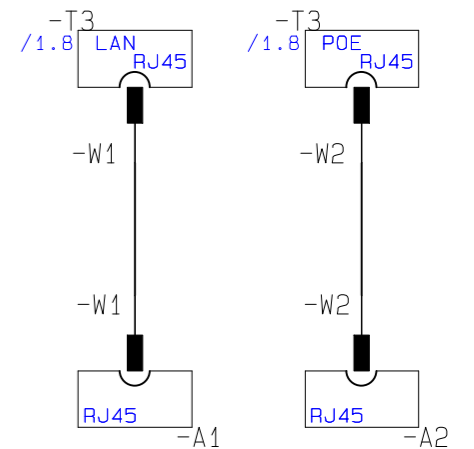

-A1 - PLC  
-A2 - WIFI ACCESS POINT

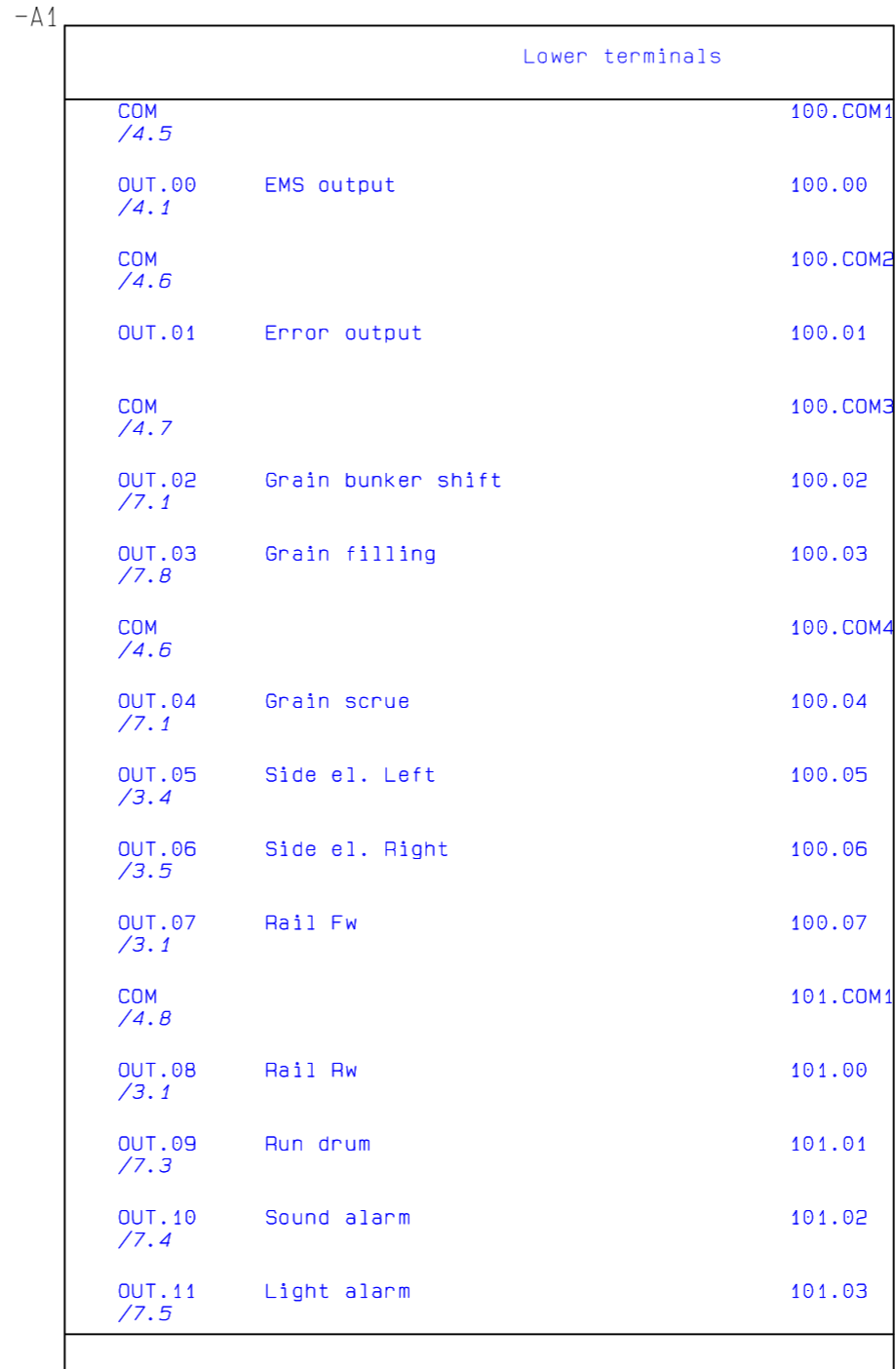
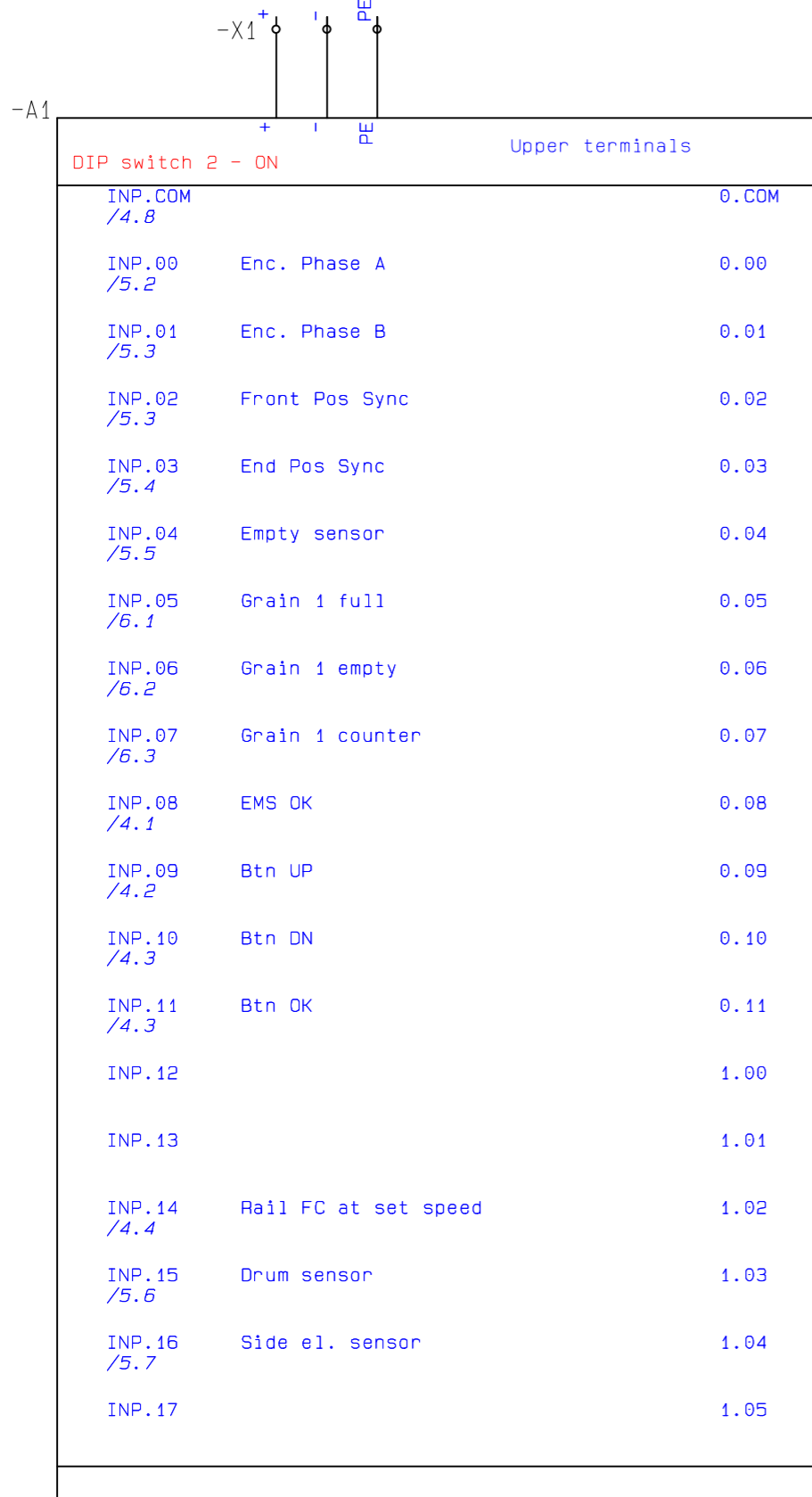
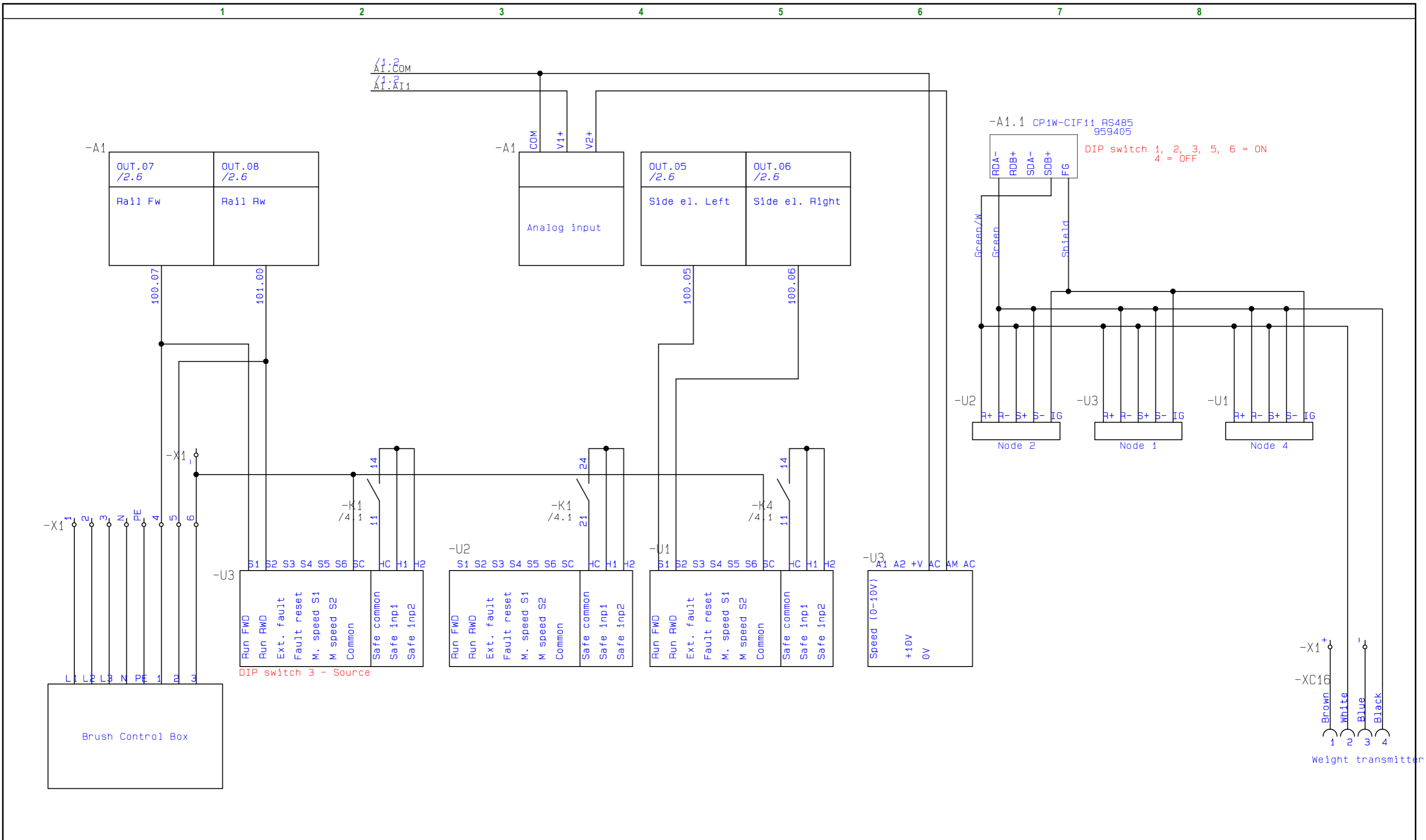

|                       |                   |                                   |  |                         |            |                         |          |
|-----------------------|-------------------|-----------------------------------|--|-------------------------|------------|-------------------------|----------|
| <b>Project title:</b> | <b>EF2019V004</b> | <b>Project no.:</b>               |  | <b>Project rev.:</b>    |            | <b>Page</b>             | <b>3</b> |
| <b>Page title:</b>    |                   | <b>Drawing no.:</b>               |  | <b>Page rev.:</b>       |            | <b>Previous page:</b>   | <b>2</b> |
| <b>Filename:</b>      | EF2019V004        | <b>Constructor (project/page)</b> |  | <b>Last printed:</b>    | 24.01.2020 | <b>Next page:</b>       | <b>4</b> |
| <b>Page ref.:</b>     |                   | <b>Appr. (date/sign.)</b>         |  | <b>Last correction:</b> | 24.01.2020 | <b>Number of pages:</b> | <b>9</b> |

|                |                |                |                |                |                      |             |             |             |             |             |                 |
|----------------|----------------|----------------|----------------|----------------|----------------------|-------------|-------------|-------------|-------------|-------------|-----------------|
| OUT.00<br>/2.6 | INP.08<br>/2.3 | INP.09<br>/2.3 | INP.10<br>/2.3 | INP.11<br>/2.3 | INP.14<br>/2.3       | COM<br>/2.6 | COM<br>/2.6 | COM<br>/2.6 | COM<br>/2.6 | COM<br>/2.6 | INP.COM<br>/2.3 |
| EMS output     | EMS OK         | Btn UP         | Btn DN         | Btn OK         | Rail FC at set speed |             |             |             |             |             |                 |

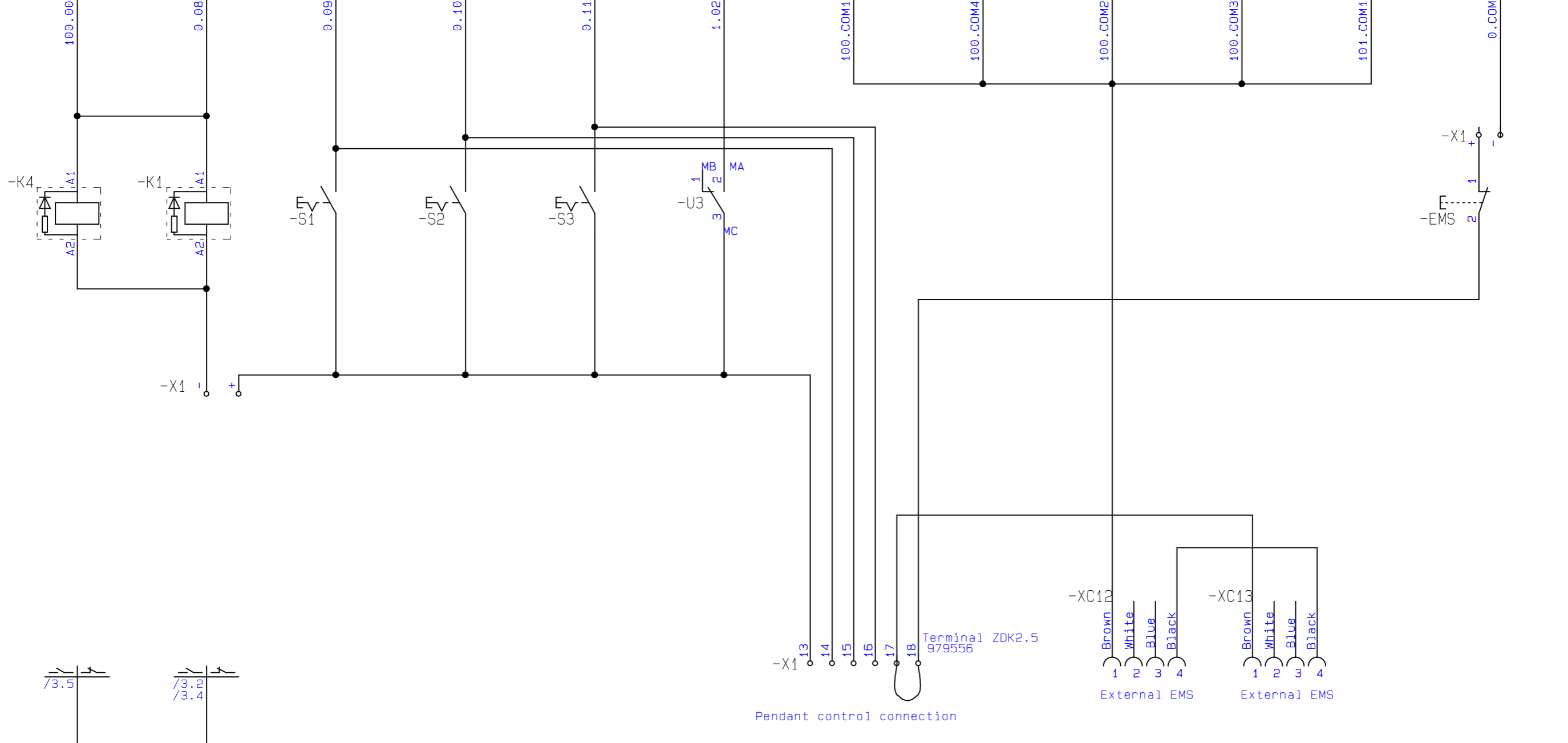

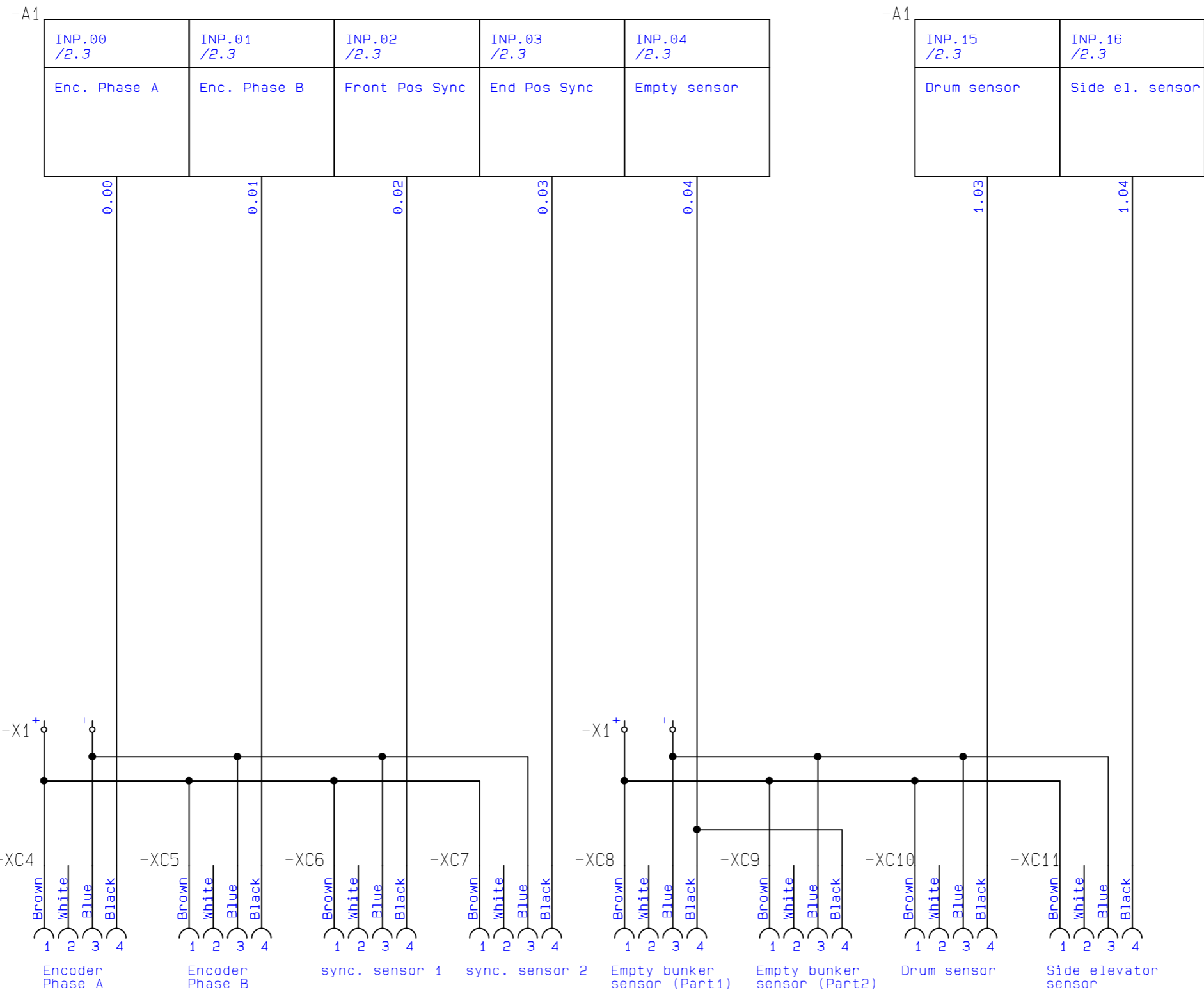

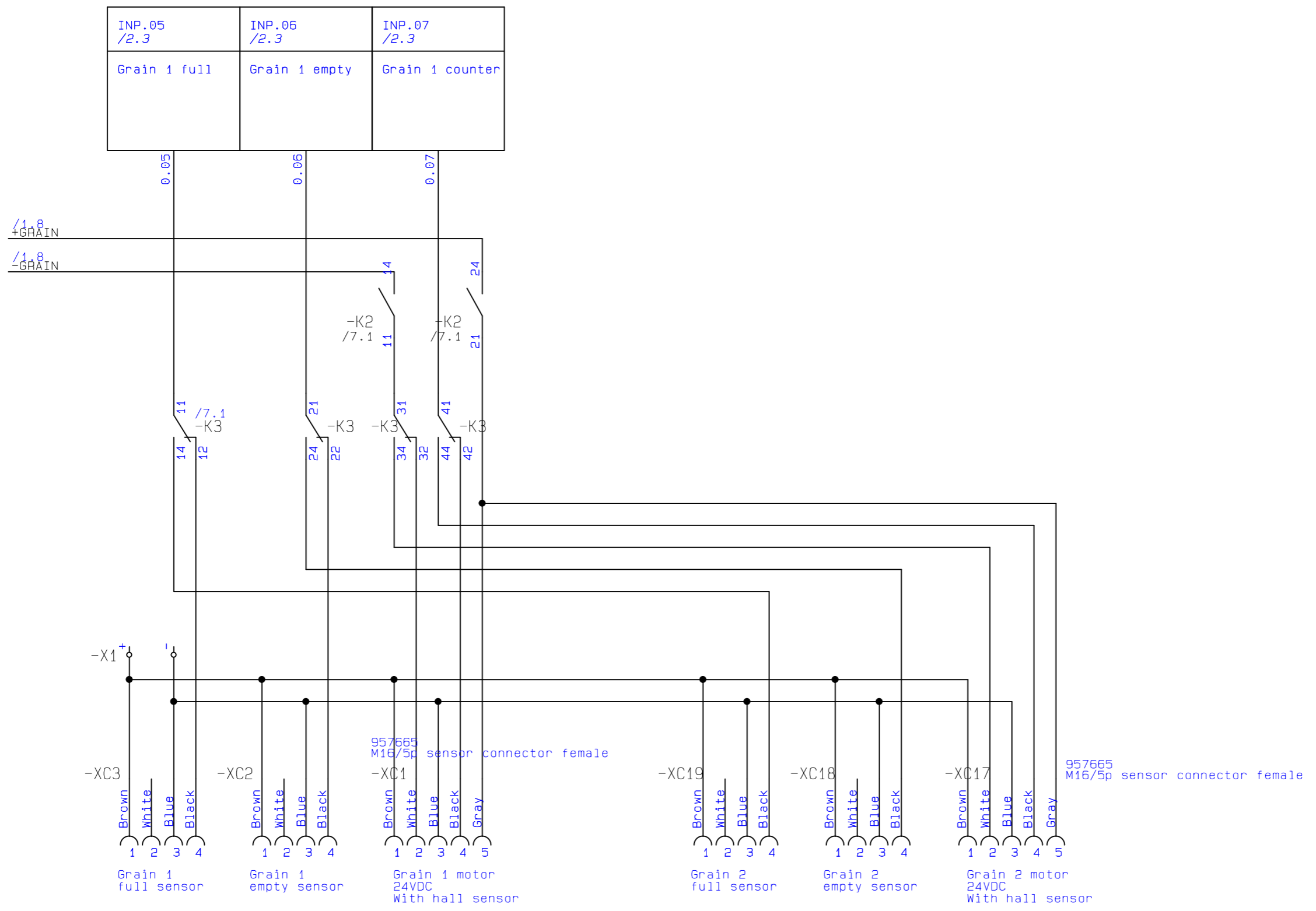

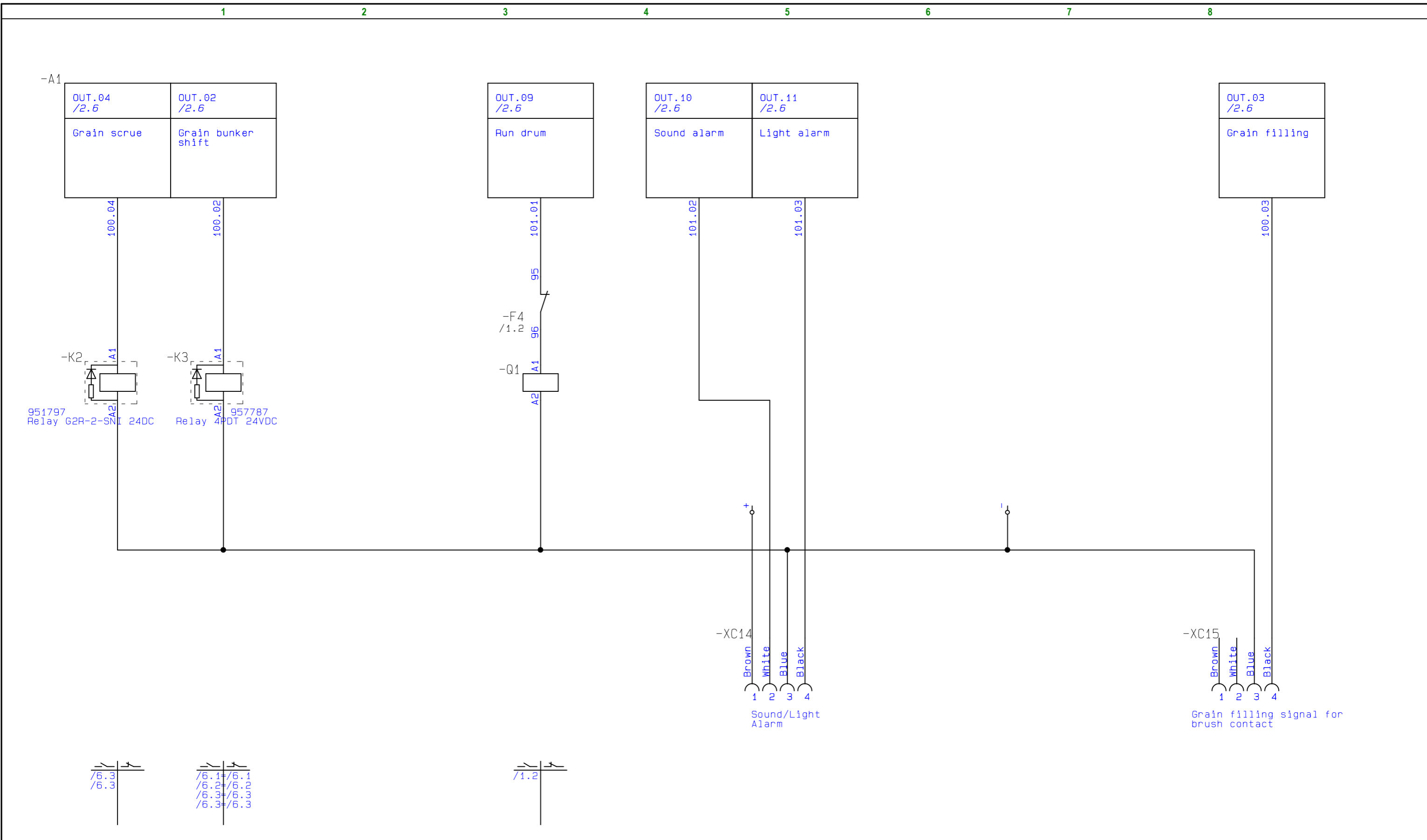

1

2

3

4

5

6

7

8

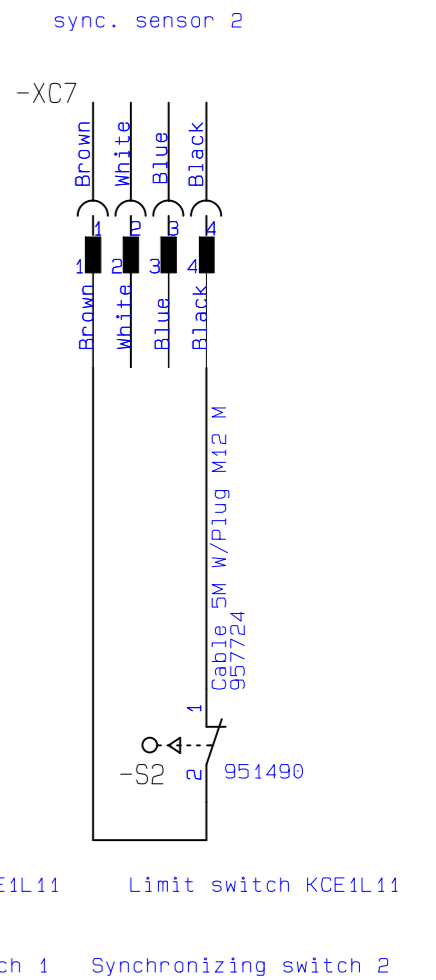
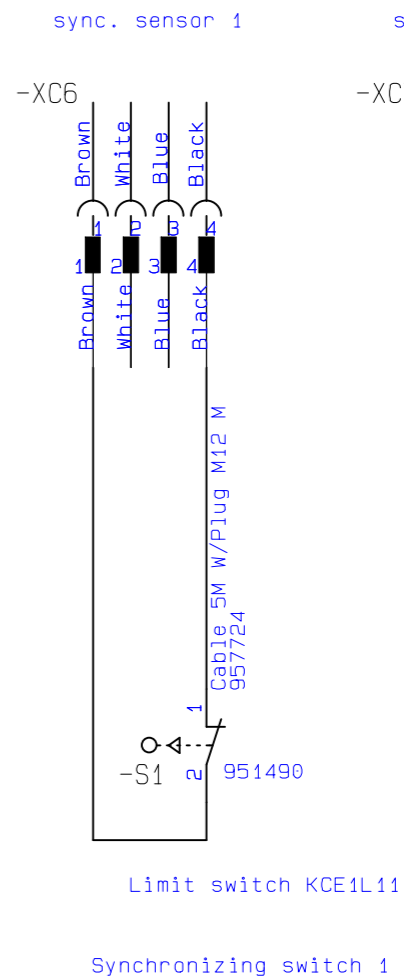
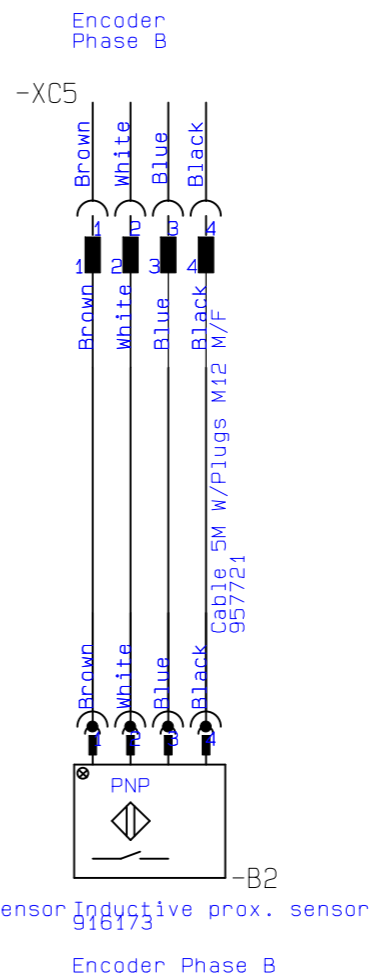
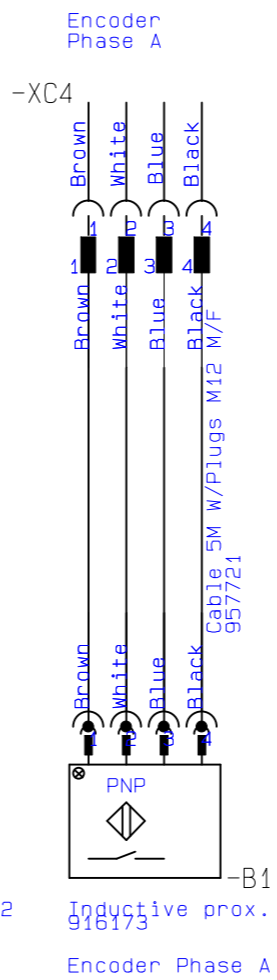
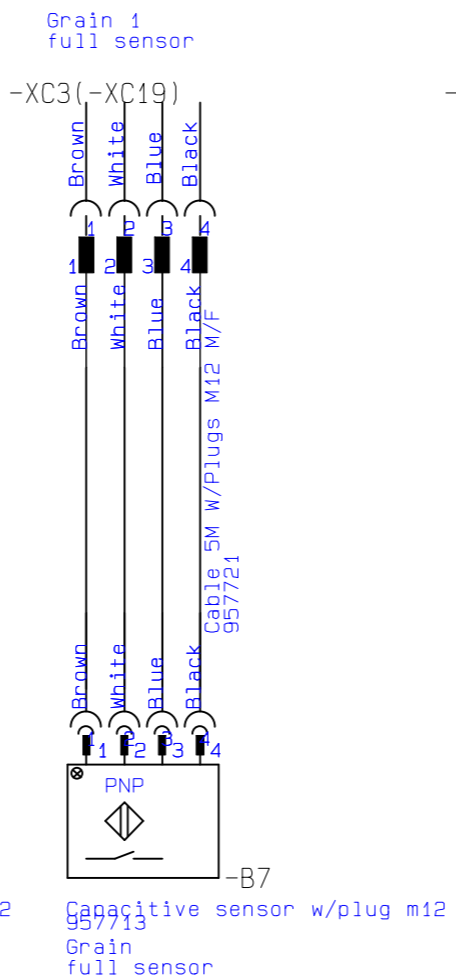
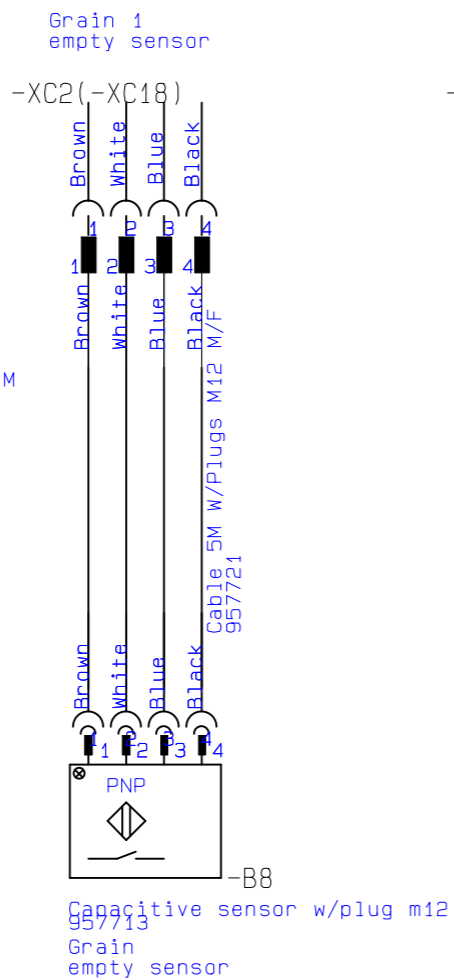
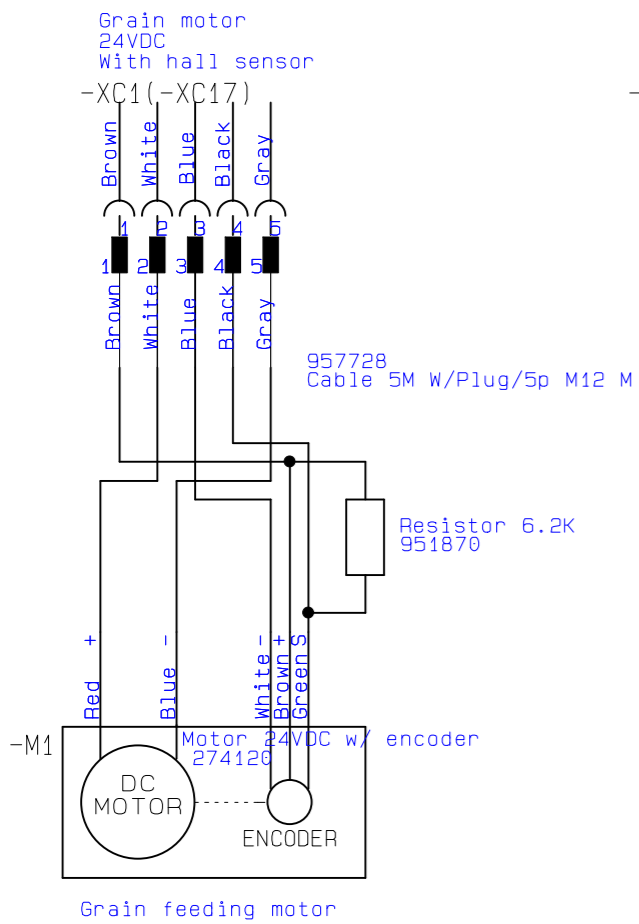



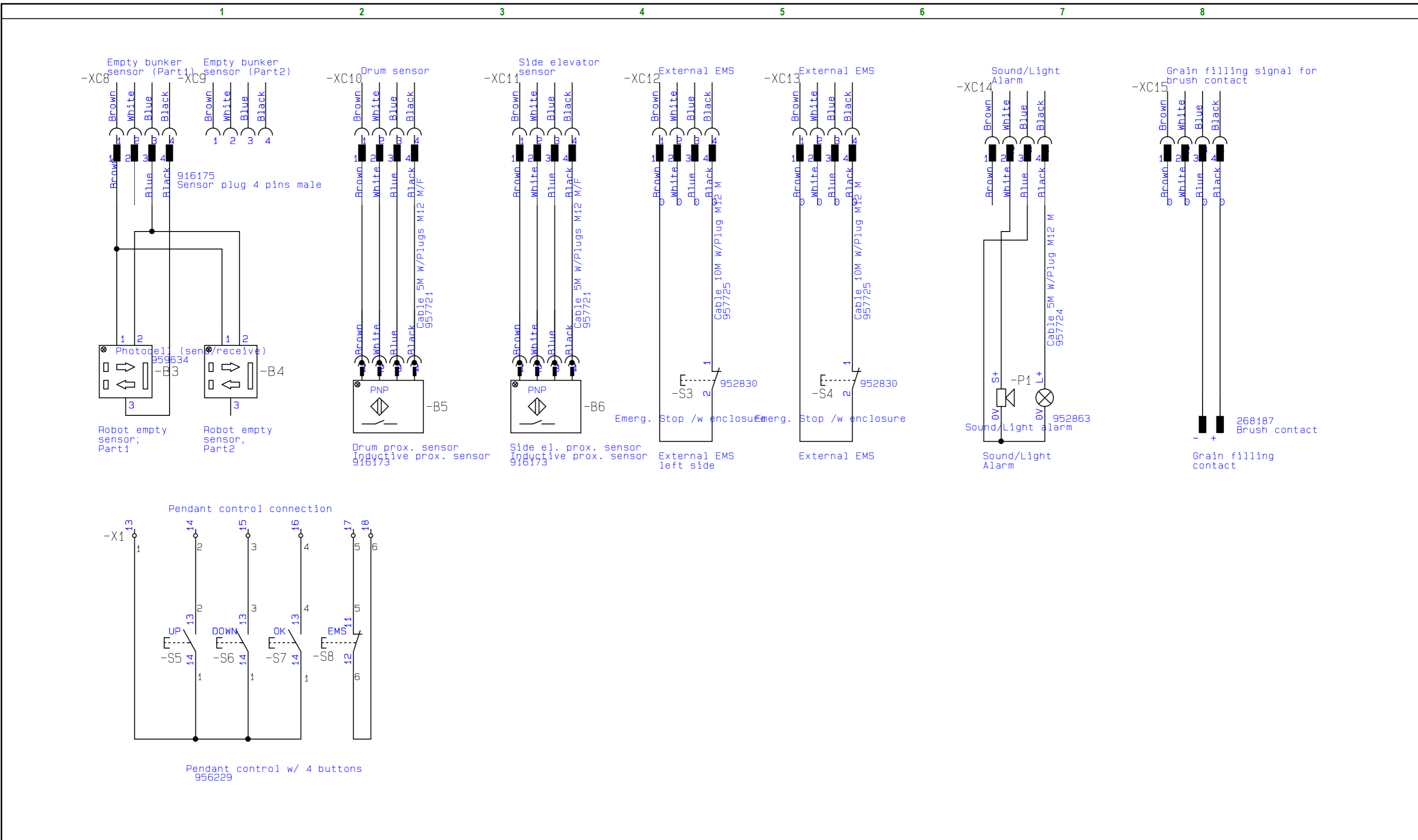

|                       |                   |                                   |                                    |                         |          |
|-----------------------|-------------------|-----------------------------------|------------------------------------|-------------------------|----------|
| <b>Project title:</b> | <b>EF2019V004</b> | <b>Project no.:</b>               | <b>Project rev.:</b>               | <b>Page</b>             | <b>9</b> |
| <b>Page title:</b>    |                   | <b>Drawing no.:</b>               | <b>Page rev.:</b>                  | <b>Previous page:</b>   | <b>8</b> |
| <b>Filename:</b>      | EF2019V004        | <b>Constructor (project/page)</b> | <b>Last printed:</b> 24.01.2020    | <b>Next page:</b>       |          |
| <b>Page ref.:</b>     |                   | <b>Apr. (date/sign.)</b>          | <b>Last correction:</b> 01.02.2019 | <b>Number of pages:</b> | <b>9</b> |